



**Aluminum corner shelf**

Model H19-0027  
H.65 W.295 D.200mm  
¥2,200+税



**Aluminum wall rack**

Model H19-0022  
H.190 W.500 D.155mm  
¥5,400+税



**Aluminum wall shelf**

Model H19-0026  
H.67 W.400 D.140mm  
¥2,400+税



**Aluminum wall shelf 2tier**

Model H19-0025  
H.355 W.400 D.140mm  
¥5,200+税



**Aluminum wall rack**



Model H19-0023  
H.220 W.600 D.250mm  
¥8,000+税

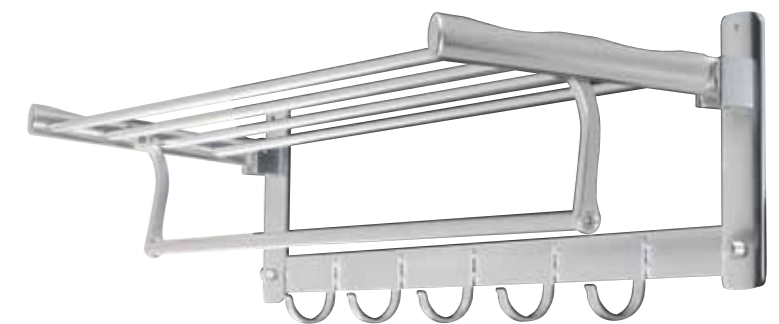

Model H19-0024  
H.170 W.603 D.235mm  
¥6,500+税





### Aluminum door handle

材質：アルミニウム



Model **D21-0328**  
H.60 W.136 D.50mm  
¥2,400+税  
4 997337 076807



Model **D21-0329**  
H.120 W.90 D.60mm  
¥7,700+税  
4 997337 076814



Model **D21-0331**  
H.60 W.110 D.42mm  
¥2,200+税  
4 997337 076845



### Aluminum bar handle

材質：アルミニウム



**S**  
Model **D21-0330S**  
H.300 W.35 D.65mm  
¥4,300+税  
4 997337 076838



**L**  
Model **D21-0330L**  
H.600 W.40 D.65mm  
¥6,100+税  
4 997337 076821



### Stainless magnetic tool holder

材質：18-8ステンレススチール、マグネット  
取付け用ネジ 2pcs 付属



**25**  
Model **G655-750-25**  
H.47 W.250 D.15mm  
¥2,600+税



**45**  
Model **G655-750-45**  
H.47 W.450 D.15mm  
¥3,600+税



### Bamboo magnetic tool holder

材質：バンブー、マグネット  
取付け用ネジ 2pcs 付属



**25**  
Model **G655-752-25**  
H.65 W.250 D.20mm  
¥2,700+税



**45**  
Model **G655-752-45**  
H.65 W.450 D.20mm  
¥4,200+税



### Aluminum wall mount tray

**Portrait**  
Model **Y959-1248PR**  
H.87 W.150 D.250mm  
¥3,800+税



### Photo frame with key storage

Model **K725-936**  
H.130 W.285 D.35mm  
photo size: 88×88mm /each  
¥2,600+税



### Wall organizer



**A**  
Model **K725-935A**  
H.240 W.230 D.70mm  
magnet X 5pcs  
¥3,500+税



**B**  
Model **K725-935B**  
H.200 W.300 D.70mm  
magnet X 2pcs  
¥3,500+税



NEW ARRIVAL

FURNITURE

HOUSEWARE

GARDEN &

STATIONERY



**Belt bracket**  
Model Y955-1249  
H.168 W.40 D.230mm  
¥1,600+税

木板サイズ: H.25 D.200mm 以内  
※1×8材(19×184mm)が綺麗に収まります。



**Belt bracket with ring**  
Model Y955-1249R  
H.168 W.40 D.230mm  
¥1,800+税

木板サイズ: H.25 D.200mm 以内  
※1×8材(19×184mm)が綺麗に収まります。  
リングに入る丸棒サイズ: φ25mm 以内



**Adjustable bracket**



**S**  
Model K655-699S  
H.90 L.120 D.35mm  
¥600+税



**L**  
Model K655-699L  
H.140 L.180 D.55mm  
¥1,400+税



**Bracket plain**



**S**  
Model K655-700S  
H.73 L.93 D.45mm  
¥600+税



**L**  
Model K655-700L  
H.90 L.112 D.52mm  
¥800+税



**Hanging bracket**  
Model R855-1009  
H.175 W.32 D.160mm  
¥980+税



**Bracket 12**  
Model S555-376-12  
H.120 L.120 D.26mm  
¥450+税



**Bracket**  
Model S555-376  
H.185 L.185 D.30mm  
¥850+税

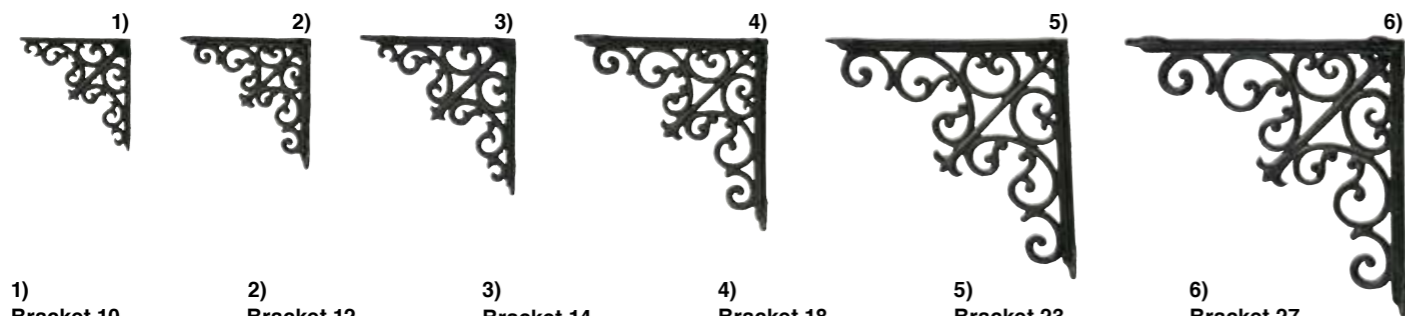

**1) Bracket 10**  
Model S355-85-10ABK  
H.100 L.100mm  
¥600+税



**2) Bracket 12**  
Model S355-85-12ABK  
H.125 L.125mm  
¥700+税



**3) Bracket 14**  
Model S355-85-14ABK  
H.140 L.140mm  
¥800+税



**4) Bracket 18**  
Model S355-85-18ABK  
H.180 L.180mm  
¥1,000+税



**5) Bracket 23**  
Model S355-85-23ABK  
H.230 L.230mm  
¥1,200+税



**6) Bracket 27**  
Model S355-85-27ABK  
H.270 L.270mm  
¥1,600+税



**Bow bracket "10"**  
Model S555-353-10  
H.100 W.100mm  
¥450+税



**Bow bracket "12"**  
Model S555-353-12  
H.125 W.125mm  
¥500+税



**Bow bracket "14"**  
Model S555-353-14  
H.140 W.140mm  
¥700+税

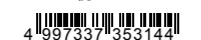

**Bow bracket "19"**  
Model S555-353-19  
H.195 L.195mm  
¥900+税



**Bow bracket "25"**  
Model S555-353-25  
H.250 L.250mm  
¥1,900+税



**Bracket**  
Model S555-375  
H.210 L.210 D.25mm  
¥1,200+税



**Bar 25**  
H.70 W.250 D.60mm  
¥800+税

材質: アイアン  
取付ネジ付属



**Bar 50**  
H.70 W.500 D.60mm  
¥850+税

材質: アイアン  
取付ネジ付属



**Bar 60**  
H.70 W.600 D.60mm  
¥950+税

材質: アイアン  
取付ネジ付属

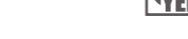

**Bar 70**  
H.70 W.700 D.60mm  
¥1,000+税

材質: アイアン  
取付ネジ付属

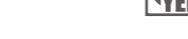

**Triangle hook**

H.160 W.160 D.50mm  
¥750+税

材質: アイアン  
取付ネジ付属

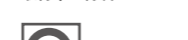

**Black**  
Model D20-0121BK  
4 997337 063548



**Black**  
Model D20-0122-2BK  
4 997337 064378



**Black**  
Model D20-0122-5BK  
4 997337 063555



**Gold**  
Model D20-0122-5GD  
4 997337 063562

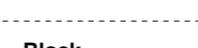

**Black**  
Model D20-0122-6BK  
4 997337 063579



**Gold**  
Model D20-0122-6GD  
4 997337 063586

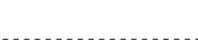

**Black**  
Model D20-0122-7BK  
4 997337 063593



**Gold**  
Model D20-0122-7GD  
4 997337 063609

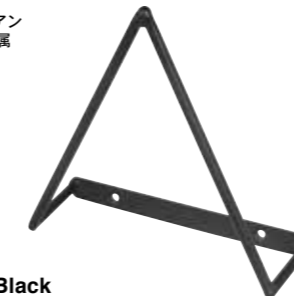

Side



**Gold**  
Model D20-0121GD  
4 997337 063531



◎こちらのページに掲載されている製品は、アンティークの雰囲気を出す為の仕上げ(色ムラ・塗装はがれ等)が施されており、塗装の風合いに多少の個体差があります。◎設置面に「サビ」が色移りする場合がございます。製品の特性としてご理解下さい。

◎こちらのページに掲載されている製品は、アンティークの雰囲気を出す為の仕上げ(色ムラ・塗装はがれ等)が施されており、塗装の風合いに多少の個体差があります。◎設置面に「サビ」が色移りする場合がございます。製品の特性としてご理解下さい。



**Iron hook S**  
Model S255-91S/ABK  
H.120 W.35 D.45mm  
¥600+税  
4 997337 959117



**Ceiling s-hook**  
Model K655-702  
H.78 W.48 D.98mm  
¥500+税  
4 997337 657020



**Small double hook**  
Model S255-101ABK  
H.80 W.32 D.48mm  
¥360+税  
4 997337 510196



**Small single hook**  
Model S255-100ABK  
H.33 W.24 D.33mm  
¥300+税  
4 997337 510097



**Wall hook**  
Model S255-92ABK  
H.75 W.35 D.85mm  
¥400+税  
4 997337 559218



**Handle**  
Model K555-499  
**S**  
H.270 W.30 D.75mm  
¥1,000+税  
4 997337 549912



**L**  
H.350 W.35 D.75mm  
¥1,600+税  
4 997337 549936



**Door Handle**  
Model K555-502  
**S**  
H.240 W.42 D.55mm  
¥780+税  
4 997337 550215



**L**  
H.310 W.45 D.60mm  
¥1,200+税  
4 997337 550239



**2 swing wall hook**  
Model S255-89ABK  
H.57 W.42 D.125mm  
¥600+税  
4 997337 558914



**Double swing wall hook**  
Model S255-88ABK  
H.83 W.40 D.70mm  
¥400+税  
4 997337 558815



**Wave hook**  
Model S355-107ABK  
H.190 W.40 D.175mm  
¥640+税  
4 997337 107990



**Cloth rack hook**  
Model S355-108ABK  
H.160 W.40 D.175mm  
¥500+税  
4 997337 108997



**Ceiling hook 60**  
Model S355-89ABK  
H.75 W.60 D.48mm  
¥360+税  
4 997337 955898



**Ceiling hook**  
Model S255-99ABK  
H.100 W.105 D.70mm  
¥600+税  
4 997337 559911



**Cats hook**  
Model HL4360-6ABK  
H.90 W.200mm  
¥1,143+税  
4 997337 943604



**Bull skull hook**  
Model S555-379  
H.145 L.140 D.65mm  
¥900+税  
Color  
Classic ivory 4 997337 537919  
Antique black 4 997337 537995



**2 branch hook**  
Model S355-92ABR  
H.90 W.135 D.58mm  
¥500+税  
4 997337 559287



**V branch hook**  
Model S355-90ABR  
H.90 W.35 D.62mm  
¥460+税  
4 997337 855907



**2 branch hook S**  
Model S355-91S/ABR  
H.200 W.100 D.60mm  
¥760+税  
4 997337 591812



**Lizard hook**  
Model S255-90ABK  
H.180 W.86 D.50mm  
¥780+税  
4 997337 559010



**Hook with chain S**  
Model K555-503S  
L.740mm  
¥2,900+税  
4 997337 555036

○フックの反対側はチェーンのみの仕様となります。

**Door Handle**  
Model K555-500



**S**  
H.150 W.30 D.35mm  
¥350+税  
4 997337 550017



**L**  
H.250 W.50 D.65mm  
¥840+税  
4 997337 550031

**Ceiling Ring**  
Model S855-1008



**S**  
Model R855-1008S  
H.80 W.80 D.33mm  
リング内径φ約25mm  
¥680+税  
4 997337 810814



**L**  
Model R855-1008L  
H.105 W.120 D.57mm  
リング内径φ約25mm  
¥1,600+税  
4 997337 810838

◎こちらのページに掲載されている製品は、アンティークの雰囲気を出す為の仕上げ(色ムラ・塗装はがれ等)が施されています。  
◎塗装の風合いに多少の個体差があります。  
◎設置面に「サビ」が色移りする場合がございます。製品の特性としてご理解ください。

材質：アイアン ネジ付属

◎こちらのページに掲載されている製品は、アンティークの雰囲気を出す為の仕上げ(色ムラ・塗装はがれ等)が施されています。  
◎塗装の風合いに多少の個体差があります。◎設置面に「サビ」が色移りする場合がございます。製品の特性としてご理解下さい。

材質：アイアン ネジ付属



**Square pull handle 13**  
Model. R655-846-13  
H.33 W.130 D.40mm  
¥420+税



**Square pull handle 8**  
Model. R655-846-8  
H.20 W.80 D.25mm  
¥320+税



**Half round pull handle**  
Model. R655-845  
H.22 W.95 D.30mm  
¥280+税



**Pull handle**  
Model. K555-501  
H.45 W.120 D.35mm  
¥350+税

材質：アイアン  
ネジ付属



**Pull handle**  
Model S255-102ABK  
H.25 W.110 D.35mm  
¥360+税



**Card pull**  
Model S255-104ABK  
H.55 W.85 D.25mm  
¥360+税



**Card pull**  
Model S255-105ABK  
H.47 W.80 D.22mm  
¥360+税



**Finger pull**  
Model K655-701  
H.30 W.55 D.25mm  
¥300+税



材質：アイアン  
ネジ付属



**Left direction**  
Model S355-93ABK  
H.56 W.128 D.15mm  
¥400+税



**Right direction**  
Model S355-94ABK  
H.56 W.128 D.15mm  
¥400+税

材質：アイアン  
ネジ付属



**Dinner bell**  
Model S255-83ABK  
H.130 φ68mm  
¥800+税



材質：アイアン



**Hanging sign 28**  
Model R655-747-28  
H.190 W.280 D.35mm  
Board H.110 W.240mm  
¥1,800+税

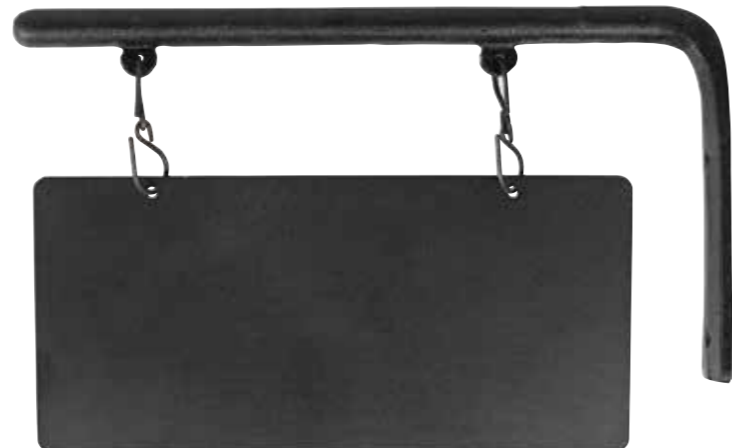

**Hanging sign 35**  
Model R655-747-35  
H.230 W.350 D.45mm  
Board H.160 W.300mm  
¥2,600+税

材質：アイアン



**Metal chalkboard**

材質：スチール



**13**  
Model K955-1264-13  
H.135 W.210 D.75mm  
¥1,400+税



**27**  
Model K955-1264-27  
H.270 W.210 D.140mm  
¥2,500+税

◎こちらのページに掲載されている製品は、アンティークの雰囲気を出す為の仕上げ(色ムラ・塗装はがれ等)が施されており、  
◎塗装の風合いに多少の個体差があります。 ◎設置面に「サビ」が色移りする場合がございます。製品の特性としてご理解下さい。

◎こちらのページに掲載されている製品は、アンティークの雰囲気を出す為の仕上げ(色ムラ・塗装はがれ等)が施されており、  
◎塗装の風合いに多少の個体差があります。 ◎設置面に「サビ」が色移りする場合がございます。製品の特性としてご理解下さい。



**Spinner sign stand open-closed**  
H.985~1240 W.400 D.235mm  
¥7,200+税

- ◎看板部分を回転させる事で OPEN、CLOSE が切り替わります。
- ◎強風時は転倒等の恐れがありますのでご使用をお控え頂くか、「重し」等でしっかりと固定してご使用下さい。雨天時の屋外でのご使用はお止め下さい。

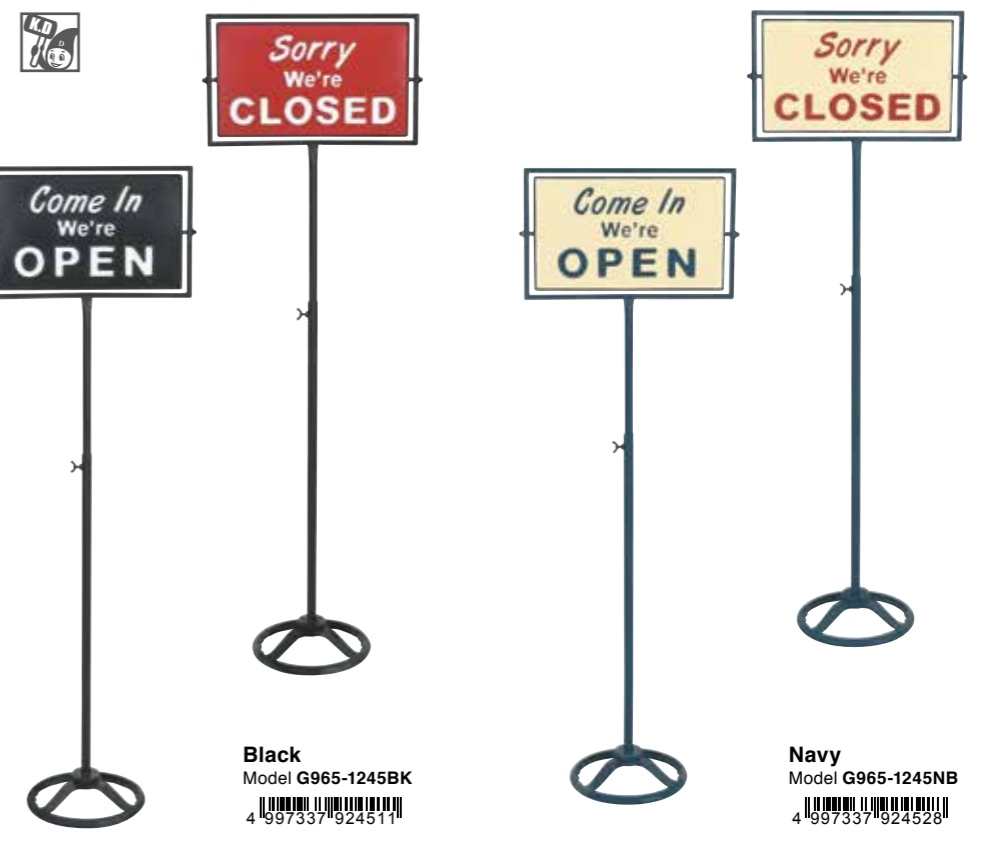

**Black**  
Model G965-1245BK  
4 997337 924511

**Navy**  
Model G965-1245NB  
4 997337 924526

**Wall mount spinner sign open-closed**  
H.610 W.200 D.105mm  
取付ネジ付属 4pcs  
¥5,400+税



- ◎看板部分を回転させる事で OPEN、CLOSE が切り替わります。



**Black**  
Model G965-1246BK  
4 997337 924610

**Navy**  
Model G965-1246NB  
4 997337 924627



**Open-closed sign stand**  
Model S355-83  
H.1060 W.570 D.235mm  
¥11,000+税  
4 997337 355834

**Folding sign board stand**  
Model S355-39  
H.1035 W.500 D.395mm  
Board H.820 W.415mm  
Folding H.1150 W.500mm  
¥10,000+税  
4 997337 447126

- ◎強風時は転倒等の恐れがありますのでご使用をお控え頂くか、「重し」等でしっかりと固定してご使用下さい。
- ◎雨天時の屋外でのご使用はお止め下さい。

- ◎チョークやマグネットが使用できます。
- ◎片面のみ書き込み可能。
- ◎強風時は転倒等の恐れがありますのでご使用をお控え頂くか、「重し」等でしっかりと固定してご使用下さい。
- ◎雨天時の屋外でのご使用はお止め下さい。

- ◎こちらのページに掲載されている製品は、アンティークの雰囲気を出す為の仕上げ(色ムラ・塗装はがれ等)が施されています。
- ◎塗装の風合いに多少の個体差があります。
- ◎設置面に「サビ」が色移りする場合がございます。製品の特性としてご理解下さい。

**Square sign "WiFi"**

Model S355-116  
H.127 W.127mm  
¥900+税



Classic ivory base  
4 997337 151160



Antique black base  
4 997337 951166



Sign P.F.C.O  
Model K655-706  
H.370 W.245mm  
¥4,000+税  
4 997337 557061

**Square sign "NO SMOKING"**

Model S355-117  
H.127 W.127mm  
¥900+税



Classic ivory base  
4 997337 011174



Antique black base  
4 997337 091176



**Iron sign "Bicycle parking"**

Model R855-994  
H.145 W.195 D.5mm  
¥1,200+税



Black  
4 997337 899413



Blue  
4 997337 899420

**Iron sign "NO PARKING"**

Model R655-745  
H.120 W.190 D.5mm  
¥1,000+税

4 997337 657457



Reversible sign stand  
"CASHIER"  
Model R655-744  
H.80 W.160 D.65mm  
¥1,000+税  
4 997337 657440



Reversible sign stand  
Open-close  
Model S455-1800C  
H.95 W.165 D.72mm  
¥1,300+税  
4 997337 551809  
◎両面がご利用頂けます。



Reversible sign stand  
Reserved  
Model S455-175RE  
H.85 W.155 D.72mm  
¥1,000+税  
4 997337 451758  
◎両面がご利用頂けます。  
◎両面とも、[RESERVED]表示のタイプです。



Reversible sign stand  
Model S455-1750C  
H.85 W.155 D.72mm  
¥1,000+税  
4 997337 551755  
◎両面がご利用頂けます。

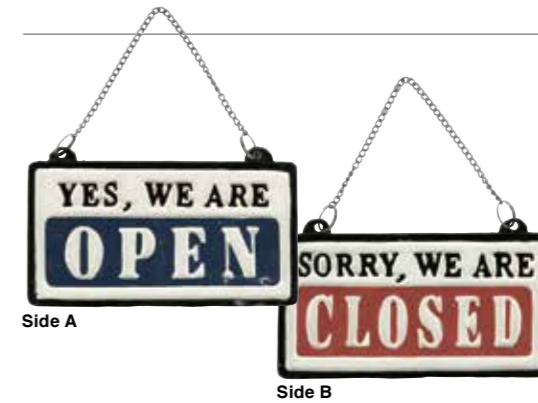

Reversible sign  
Model S455-1740C  
H.95 W.165mm  
¥1,300+税  
4 997337 551748  
◎両面がご利用頂けます。

**Iron sign**

"GENTS"  
Model 2402  
H.50 W.163mm  
¥900+税  
4 997337 402392



"SMOKING AREA"  
Model 2428  
H.50 W.250mm  
¥1,400+税  
4 997337 224284



"LADIES"  
Model 403  
H.50 W.163mm  
¥900+税  
4 997337 403399



"NO SMOKING"  
Model 2429  
H.50 W.220mm  
¥1,200+税  
4 997337 224291



"PRIVATE"  
Model 404  
H.50 W.197mm  
¥900+税  
4 997337 404396



"STAFF ONLY"  
Model 2430  
H.50 W.225mm  
¥1,200+税  
4 997337 224307



"TOILET"  
Model 405  
H.50 W.175mm  
¥900+税  
4 997337 405393



"OFFICE"  
Model 2432  
H.50 W.175mm  
¥900+税  
4 997337 224321



"Wi-Fi"  
Model 2514  
H.50 W.150mm  
¥900+税  
4 997337 325141



◎こちらの製品は、アンティークの雰囲気を出す為の仕上げ(色ムラ・塗装はがれ等)が施されております。  
◎塗装の風合いに多少の個体差があります。◎設置面に「サビ」が色移りする場合がございます。製品の特性としてご理解下さい。

**Brass sign** 材質: 真鍮



"GENTS"

"STAFF ONLY"



"LADIES"

"OFFICE"



"PRIVATE"

"WI-FI"



"TOILET"

"BATHROOM"



"WELCOME"

"KITCHEN"

Model GS559-326  
H.23 W.145 D.4mm  
プラスネジ付属  
¥900+税



付属品: プラスネジ×2pcs  
(マイナスタイプ)



"PUSH"

Model GS559-326PS  
H.20 W.63 D.4mm  
プラスネジ付属  
¥580+税



"PULL"

Model GS559-326PL  
H.20 W.63 D.4mm  
プラスネジ付属  
¥580+税



"PUSH"

Model GS559-326PS2  
H.80 W.20 D.4mm  
プラスネジ付属  
¥680+税



"PULL"

Model GS559-326PL2  
H.80 W.20 D.4mm  
プラスネジ付属  
¥680+税



Model GS559-326MYH  
H.40 W.205 D.4mm  
プラスネジ付属  
¥2,500+税



Model GS559-326MYH2  
H.54 W.143 D.4mm  
プラスネジ付属  
¥2,300+税



Color	Model	Price
	GENTS GS559-326GE	¥900+税
	LADIES GS559-326LA	¥900+税
	PRIVATE GS559-326PR	¥900+税
	TOILET GS559-326TO	¥900+税
	WELCOME GS559-326WLC	¥900+税
	STAFF ONLY GS559-326ST	¥900+税
	OFFICE GS559-326OF	¥900+税
	WI-FI GS559-326WF	¥900+税
	BATHROOM GS559-326BR	¥900+税
	KITCHEN GS559-326KC	¥900+税
	PLEASE MIND YOUR HEAD GS559-326MYH 1行タイプ	¥2,500+税
	PLEASE MIND YOUR HEAD GS559-326MYH2 2行タイプ	¥2,300+税
	PUSH GS559-326PS 横タイプ	¥580+税
	PULL GS559-326PL 横タイプ	¥580+税
	PUSH GS559-326PS2 縦タイプ	¥680+税
	PULL GS559-326PL2 縦タイプ	¥680+税

◎こちらのページに掲載されている製品はハンドメイドで生産されております。  
サイズ等の若干の個体差が生じる場合がございます。  
◎生産工程中に細かなキズや塗装剥げ等が生じる場合がございますが製品の特性として予めご了承ください。

**Enameled sign**

H.40 W.210 D.5mm  
¥800+税  
材質: エナメル、スチール  
取付ネジ付属



Staff only

Model H20-0145SO



Smoking area

Model H20-0145SA



No smoking

Model H20-0145NS

H.40 W.150 D.5mm  
¥700+税  
材質: エナメル、スチール  
取付ネジ付属



Men

Model H20-0145MN



Push

Model H20-0145PS



Private

Model H20-0145PR



Toilet

Model H20-0145TO



Women

Model H20-0145WM



Pull

Model H20-0145PL



Welcome

Model H20-0145WE

**Enameled notice sign**

H.120 W.170 D.5mm  
¥1,000+税  
材質: エナメル、スチール  
取付ネジ付属



Wash your hands

Model H20-0144WH



Hand sanitizer

Model H20-0144HS



No parking

Model H20-0144NP



Take out

Model H20-0144TO



Security camera

Model H20-0144SC



Beware of dog

Model H20-0144BD



Blank

Model H20-0144BL





**Art frame**

H.470 W.320 D.35mm  
 ¥3,500+税  
 重量 約1.5kg



"Before sunset"  
 Model G855-1047BS  
 4 997337 847018

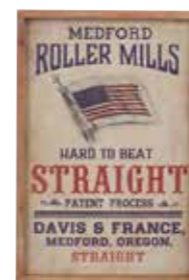

"Medford"  
 Model G855-1047MF  
 4 997337 847025



"My pal"  
 Model G855-1047MP  
 4 997337 847032



"Beaver"  
 Model G855-1047BV  
 4 997337 847049

**Art frame**

H.620 W.420 D.35mm  
 ¥5,300+税  
 重量 約2.5kg



"Bee brand"  
 Model G855-1049BBR  
 4 997337 847056



"Coffee R&G"  
 Model G855-1049CRG  
 4 997337 847063



"Carload"  
 Model G855-1049CL  
 4 997337 847070



"Mustard"  
 Model G855-1049MS  
 4 997337 847087



"Big boy"  
 Model G855-1049BBY  
 4 997337 847094

**Art frame**

H.720 W.420 D.35mm  
 ¥5,900+税  
 重量 約3kg

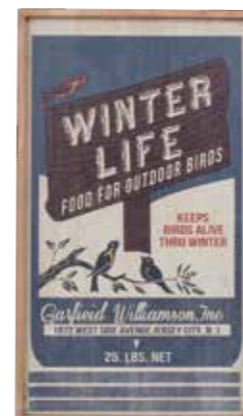

"Winter life"  
 Model G855-1050WL  
 4 997337 847100



"Indian A"  
 Model G855-1050ND  
 4 997337 847117

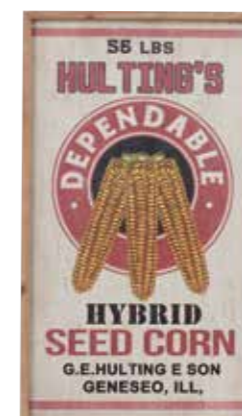

"Seed corn"  
 Model G855-1050SC  
 4 997337 847124



"Midwest master"  
 Model G855-1050MM  
 4 997337 847131

*Decoration*

Wall hanging mirror



**Cloud long**  
Model H19-0029  
H.393 W.190 D.10mm  
¥3,500+税  
4 997337 008013



**Cloud rounded**  
Model H19-0030  
H.200 W.180 D.10mm  
¥2,500+税  
4 997337 008020



**Cloud square**  
Model H19-0031  
H.340 W.258 D.10mm  
¥3,800+税  
4 997337 008051



**Cloud oblong**  
Model H19-0032  
H.250 W.175 D.10mm  
¥2,800+税  
4 997337 008082



**Cloud oval**  
Model H19-0033  
H.240 W.265 D.10mm  
¥3,000+税  
4 997337 008099



Table top mirror



**Rectangle**  
Model H19-0114  
H.377 W.320 D.127mm  
Mirror: H.300 W.198mm  
¥4,800+税  
材質：スチール、ガラス、MDF  
4 997337 063463



**Round**  
Model H19-0115  
H.370 W.405 D.147mm  
Mirror: φ270mm  
¥5,200+税  
材質：スチール、ガラス、MDF  
4 997337 063470



**Shield**  
Model H19-0113  
H.435 W.180 D.120mm  
Mirror: H.213 W.165mm  
¥3,200+税  
材質：スチール、ガラス、MDF  
4 997337 063456



**Oval**  
Model H19-0111  
H.322 W.155 D.120mm  
Mirror: H.215 W.125mm  
¥2,800+税  
材質：スチール、ガラス、MDF  
4 997337 063432



**Hexagon**  
Model H19-0112  
H.453 W.168 D.92mm  
Mirror: H.255 W.152mm  
¥3,200+税  
材質：スチール、ガラス、MDF  
4 997337 063449

GARDEN & GREEN

KITCHENWARE

STATIONERY

**Iron candle holder**

材質：アイアン(電気メッキ)

**S**

H.140 φ55mm  
Holder φ20mm  
¥1,500+税



**Antique brass**  
Model H20-0298S/ABS  
4 997337 074254



**Nickel**  
Model H20-0298S/NC  
4 997337 074285

**L**

H.220 φ55mm  
Holder φ20mm  
¥2,000+税



**Antique brass**  
Model H20-0298L/ABS  
4 997337 074278



**Nickel**  
Model H20-0298L/NC  
4 997337 074308

**M**

H.180 φ55mm  
Holder φ20mm  
¥1,700+税



**Antique brass**  
Model H20-0298M/ABS  
4 997337 074261



**Nickel**  
Model H20-0298M/NC  
4 997337 074292

◎こちらの製品は製造工程上、  
表面にキズやスレが見られる場合がありますが  
使用上問題ありません。  
◎ハンドメイドで製造されているため、  
表面加工や風合い、サイズに個体差があります。  
製品の特性としてご理解ください。  
◎キャンドルの形状によっては、  
ご使用できない場合があります。



**Cement candle**

材質：セメント、ワックス(シトロネラ成分入り)



**Cylinder S**  
Model H20-0253S/GY  
H.90 φ80mm  
¥1,500+税  
4 997337 072021



**Cylinder L**  
Model H20-0253L/GY  
H.125 φ110mm  
¥2,500+税  
4 997337 072038



**Ball**  
Model H20-0252GY  
H.118 φ120mm  
¥2,700+税  
4 997337 072014



**Square S**  
Model H20-0254S/GY  
H.90 W.80 D.80mm  
¥1,600+税  
4 997337 072045



**Square L**  
Model H20-0254L/GY  
H.125 W.110 D.110mm  
¥2,600+税  
4 997337 072069



**Iron candle stand**

材質：アイアン、ガラス



**S**

Model H19-0110S  
H.245 φ90mm  
Holder φ45mm  
¥2,000+税  
4 997337 063418



**L**

Model H19-0110L  
H.350 φ90mm  
Holder φ45mm  
¥2,200+税  
4 997337 063425



**Glass collection box**

Model R655-777AGD  
H.150 W.330 D.227mm  
¥6,900+税

材質：アイアン・ガラス・天然木

4 997337 577786



L.E.D lantern antique silver



Model R855-1043ASV  
H.280 W.170 D.190mm

¥3,600+税  
アルカリ単3電池×2pcs使用  
\*電池は付属しておりません。  
連続点灯時間(目安):約96時間  
4 997337 804325

Model R855-1044ASV  
H.300 W.145 D.160mm

¥3,600+税  
アルカリ単3電池×2pcs使用  
\*電池は付属しておりません。  
連続点灯時間(目安):約96時間  
4 997337 804424

【L.E.D LANTERNについて】

- ◎付属のLED型電球は本製品専用の仕様です。破損や発火の恐れがあり大変危険ですので他の照明器具・電気製品には、絶対に接続しないで下さい。また、他の電球を本製品に接続する等も危険ですのでお止め下さい。
- ◎本製品はアンティークの風合いを出す為の加工(色ムラ、サビ加工、塗装はがれ等)が施されており、塗装の風合いに多少の個体差があります。
- ◎本製品は屋内用です。高温多湿な場所、また火の側ではご使用にならないで下さい。
- ◎小さなお子様手の届かない場所でご使用下さい。



Glass Sound Expander

Model A555-532  
H.260 W.133 D.135mm  
¥5,300+税



4 997337 515016



Package

◎本製品は製造工程上、若干の歪みやスジ、大きさや重量に多少の個体差が生じる場合がございます。予めご了承下さい。



Candle holder Glassball

材質: ガラス  
Candles are not included.

S  
Model BG023  
H.85 φ100mm  
Holder φ40mm  
¥850+税

4 997337 272308



M  
Model BG023-1  
H.100 φ120mm  
Holder φ40mm  
¥950+税

4 997337 272315



Glass candle holder

材質: ガラス  
Candles are not included.

Model S95545S  
H.140 W.85mm  
Holder φ45mm  
¥1,334+税

4 997337 554510



Model S95545M  
H.180 W.85mm  
Holder φ45mm  
¥1,600+税

4 997337 554527



Telescoping Hat Stand

Model 2077  
H.305~475 φ160mm  
¥3,500+税

4 997337 207737



長さ調節可能

- ◎こちらの製品は、アンティークの雰囲気を出す為の仕上げ(色ムラ・塗装はがれ等)が施されています。塗装や仕上げの風合いに多少の個体差があります。製品の特性としてご理解下さい。
- ◎設置面に「サビ」が色移りする場合がございます。設置箇所にはご注意下さい。

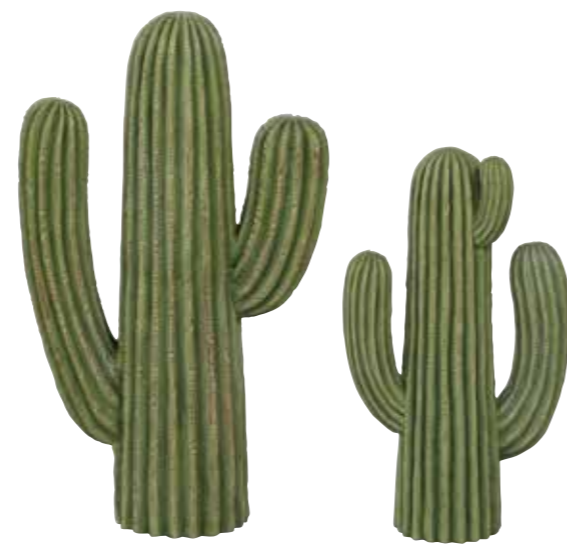

Cactus Type-D  
Model K655-657D  
H.355 W.215mm  
¥3,500+税

材質: ポリレジン  
4 997337 565745

Cactus Type-E  
Model K655-657E  
H.275 W.160mm  
¥2,500+税

材質: ポリレジン  
4 997337 565752



Metal frame

材質: スチール・ガラス

7  
Model K955-1263-7  
H.70 W.105 W.40mm  
Frame H.57 W.95mm  
¥850+税

4 997337 126335

10  
Model K955-1263-10  
H.105 W.155 D.65mm  
Frame H.95 W.145mm  
¥1,400+税

4 997337 126328



20  
Model K955-1263-20  
H.205 W.250 D.100mm  
Frame H.195 W.240mm  
¥3,000+税

4 997337 126311



**Twisted string**

Model GS555-266  
H.105 W.150mm  
100m/roll  
¥400+税

材質：コットン 35%  
ポリエステル 65%

- ◎こちらの製品はハンドメイドの為、色やサイズ等は製品によって異なります。製品の特性としてご理解下さい。
- ◎力を入れて引っ張ると切れてしまいます。取扱いは十分ご注意ください。
- ◎濃色の場合、色落ちする可能性があります。



Model GS555-266A  
WHITE / RED  
4 997337 266017



Model GS555-266C  
WHITE / BROWN  
4 997337 266031

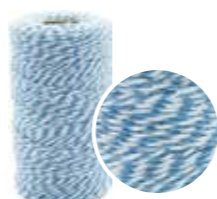

Model GS555-266D  
WHITE / SAX  
4 997337 266048



Model GS555-266E  
WHITE / MUSTARD  
4 997337 266055



Model GS555-266F  
WHITE / GRAY  
4 997337 266062



Model GS555-266G  
WHITE / BLACK  
4 997337 266079

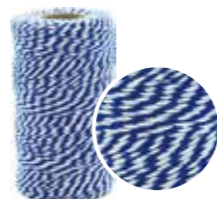

Model GS555-266H  
WHITE / NAVY  
4 997337 082662



Model GS555-266J  
WHITE / GREEN  
4 997337 092661



Model GS555-266L  
WHITE / BLUE / RED  
4 997337 266116



Model GS555-266N  
YELLOW / GRAY  
4 997337 266130



Model GS555-266Q  
WHITE / RED / GREEN  
4 997337 266154



**String holder**

Model S355-99ABK  
H.250 W.177 D.102mm  
¥2,000+税  
4 997337 935593

材質：アイアン  
付属品：ハサミ、麻紐(約100m)  
Available setting "Wool yarn"  
芯棒は2種類入っています。

◎アンティークの雰囲気を出す為の仕上げ(色ムラ、塗装剥げ、サビ)等が施されています。

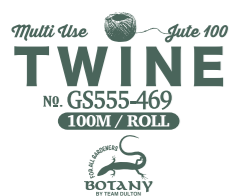

**Twine**  
Model GS555-469  
100m/roll  
¥600+税  
材質：麻



**Natural**  
4 997337 546904



**Red**  
4 997337 546928



**Tassel**  
Model SM21795  
L.550mm  
Tassel L.180mm  
¥960+税  
材質：コットン100%  
ユーカリウッド  
4 997337 217958



**Tassel**  
Model SM21797  
L.500mm  
Tassel L.150mm  
¥810+税  
材質：コットン100%  
4 997337 217972



**Curtain tassel**  
Model SM20625  
L.450mm  
Tassel L.170mm  
¥553+税  
材質：コットン  
HDPE  
4 997337 206259



**Curtain tassel**  
Model SM20627  
L.450mm  
Tassel L.170mm  
¥553+税  
材質：コットン  
HDPE  
4 997337 206273



**Curtain tassel**  
Model SM20636  
L.550mm  
Tassel L.185mm  
¥553+税  
材質：ジュート  
HDPE  
4 997337 206365



**Tassel**

Model S455-138  
L.180mm  
Tassel L.100mm  
¥550+税  
材質：ポリエステル  
木材



**Gold**  
4 997337 138994



**Ivory**  
4 997337 138000



**Turquoise / Gold**  
4 997337 138499

**Tassel**

Model S355-62  
L.155mm  
Tassel L.95mm  
¥280+税  
材質：ポリエステル



**Pink / Green**  
4 997337 353625

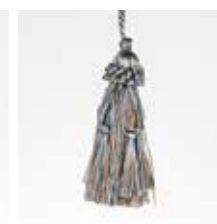

**Blue / Brown**  
4 997337 535564



**Purple / Beige**  
4 997337 735568



**Turquoise / Gold**  
4 997337 635564



導入事例：高知 蔦屋書店

制作例：ウォールコレクション

制作例：ディスプレイ

DULTON JIYUGAOKA



HUE BOOKSとは古本洋書を「インテリアの素材」として販売する、ダルトンがプロデュースする本屋です。アイデア次第で、様々なディスプレイを組む事が出来る洋書をセット販売しています。

あらゆる時代と世界から集められた洋書たちは、空間により深い世界観を与えてくれます。インテリアの装飾・ディスプレイ・店舗内装など、様々な空間にHUE BOOKSを取り入れてみてください。きっと多くの発見があるはずです。



# BOOKS WE DEAL IN

1点物のアンティークブックを背表紙全長50cm・25cmの2タイプに集約したセット販売になっており、本の高さ・厚み等はそれぞれ異なります。主にディスプレイ・装飾用としてご使用ください。



約50cm

18冊前後のセット

### Antique book 50cm

W.約500mm  
¥OPEN PRICE+税

Color	Model	Barcode
● Green	ATB-GN-50	4 997337 996501
● Red	ATB-RD-50	4 997337 992503
● Blue	ATB-BL-50	4 997337 995504
● Black	ATB-BK-50	4 997337 999502



約25cm

9冊前後のセット

### Antique book 25cm

W.約250mm  
¥OPEN PRICE+税

Color	Model	Barcode
● Green	ATB-GN-25	4 997337 259965
● Red	ATB-RD-25	4 997337 259927
● Blue	ATB-BL-25	4 997337 259958
● Black	ATB-BK-25	4 997337 259996

◎高さ：約160～260mm、奥行：約100～200mmの範囲より選出した古書のセットになります。◎セット写真は一例です。



Green



Red



Blue



Black



- アンティークブックは古物の対象です。再販される場合は、古物商許可が必要となりますのでご注意ください。
- 詳しくは営業担当にお問い合わせください。
- 古書の為、商品の至る箇所に擦れ、破れ、折れ、シミ・黄ばみや汚れ、落書き等があります。また、色味に個体差があります。商品の特性としてご理解ください。
- 本商品につきましては、古書の特性をご理解いただいた上でご購入頂けますようお願い致します。なお、本商品の返品・交換は一切受け付けておりません。あらかじめご了承ください。





### Sweater wool mat / rug (Hand weave)

**Gray**  
 材質：ウール77%、ナイロン13%、ポリエステル・コットン・ビスコース・アクリル10%

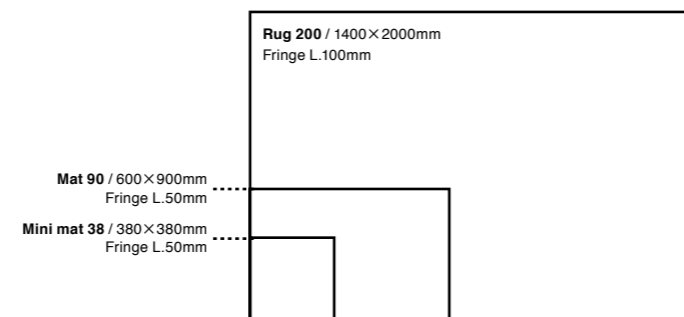

	Model	Size	Price	
	<b>Mini mat 38</b>	<b>T19-0065/38GY</b>	380×380mm	¥2,300+税
	<b>Mat 90</b>	<b>T19-0065/90GY</b>	600×900mm	¥5,800+税
	<b>Rug 200</b>	<b>T19-0065/200G</b>	1400×2000mm	¥30,000+税

◎こちらの製品は、ハンドメイドで生産されております。生産毎によりサイズや色の濃淡、材質の風合いに多少の個体差がございます。製品の特性としてご理解下さい。  
 ◎材質の性質上、設置面等に色移りする場合がございます。

### Hazy lattice wool mat / rug (Hand weave)

**Natural×Black**  
 材質：表面 ウール100%、裏面 コットン100%、滑り止め ラテックス

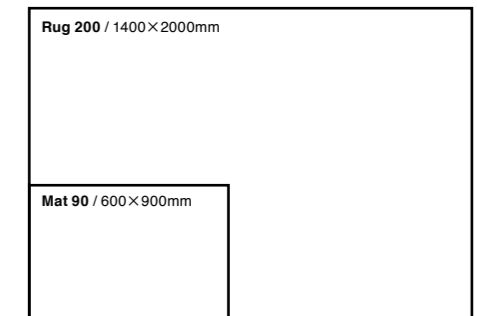

	Model	Size	Price	
	<b>Mat 90</b>	<b>T19-0066/90BK</b>	600×900mm	¥5,800+税
	<b>Rug 200</b>	<b>T19-0066/200B</b>	1400×2000mm	¥30,000+税

◎こちらの製品は、ハンドメイドで生産されております。生産毎によりサイズや色の濃淡、材質の風合いに多少の個体差がございます。製品の特性としてご理解下さい。  
 ◎材質の性質上、設置面等に色移りする場合がございます。







### Heirloom wool mat / rug (Hand weave)

Natural × Brown

材質：ウール81%、コットン18%、ナイロン1%

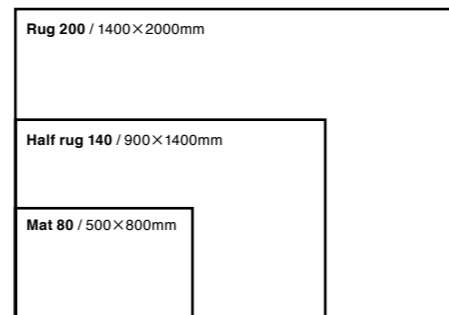
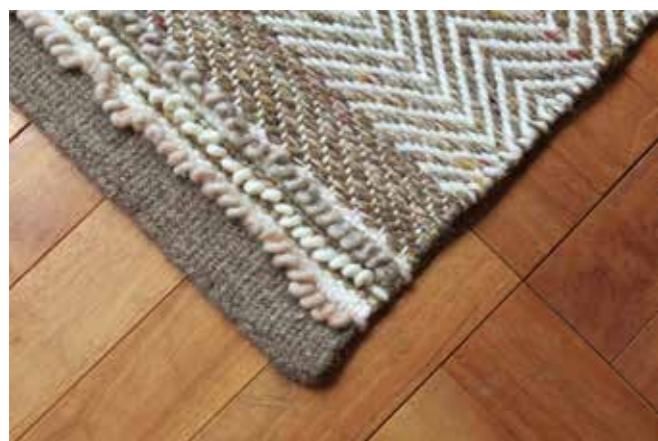

Model	Size	Price
<b>Mat 80</b>	<b>T19-0064/80BR</b> 500×800mm	¥4,300+税
<b>Half rug 140</b>	<b>T19-0064/140B</b> 900×1400mm	¥14,000+税
<b>Rug 200</b>	<b>T19-0064/200B</b> 1400×2000mm	¥30,000+税

◎こちらの製品は、ハンドメイドで生産されております。生産毎によりサイズや色の濃淡、材質の風合いに多少の個体差がございます。製品の特性としてご理解下さい。  
◎材質の性質上、設置面等に色移りする場合がございます。

### Framed wool mat / rug (Hand weave)

材質：ウール80%、コットン20%

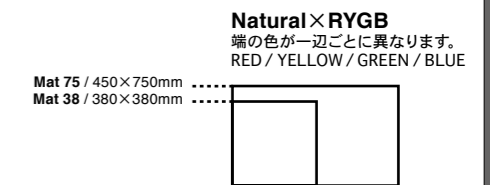

Natural × RYGB

Model	Size	Price
<b>Mat 38</b>	<b>T19-0062/38RY</b> 380×380mm	¥1,800+税
<b>Mat 75</b>	<b>T19-0062/75RY</b> 450×750mm	¥3,300+税

◎こちらの製品は、ハンドメイドで生産されております。生産毎によりサイズや色の濃淡、材質の風合いに多少の個体差がございます。製品の特性としてご理解下さい。  
◎材質の性質上、設置面等に色移りする場合がございます。

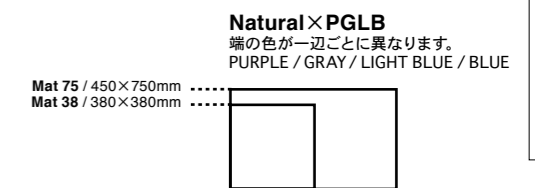

Natural × PGLB

Model	Size	Price
<b>Mat 38</b>	<b>T19-0062/38PG</b> 380×380mm	¥1,800+税
<b>Mat 75</b>	<b>T19-0062/75PG</b> 450×750mm	¥3,300+税

◎こちらの製品は、ハンドメイドで生産されております。生産毎によりサイズや色の濃淡、材質の風合いに多少の個体差がございます。製品の特性としてご理解下さい。  
◎材質の性質上、設置面等に色移りする場合がございます。

## Grid jute mat



◎写真は実際のサイズとは異なります。

### Natural×Ivory

材質：ジュート100%



Mat 60 / 300×600mm  
Fringe L.50mm



Mat 90 / 600×900mm  
Fringe L.100mm



Model	Size	Price
Mat 60 T19-0067/60IV	300×600mm	¥1,200+税
Mat 90 T19-0067/90IV	600×900mm	¥3,000+税

### Natural

材質：ジュート100%



Mat 60 / 300×600mm  
Fringe L.50mm

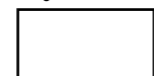

Mat 90 / 600×900mm  
Fringe L.100mm



Model	Size	Price
Mat 60 T19-0067/60NT	300×600mm	¥1,200+税
Mat 90 T19-0067/90NT	600×900mm	¥3,000+税

## Braided jute mat / rug



◎写真は実際のサイズとは異なります。

### Natural

材質：ジュート100%



Oval mat / 600×900mm

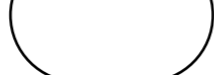

Oval rug / 800×1400mm

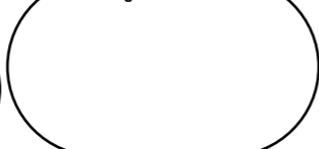

Model	Size	Price
Oval mat T19-0068S/NT	600×900mm	¥2,800+税
Oval rug T19-0068M/NT	800×1400mm	¥5,800+税

## Somak jute mat / rug



◎写真は実際のサイズとは異なります。

### Natural

材質：ジュート100%



Half rug 140 / 900×1400mm

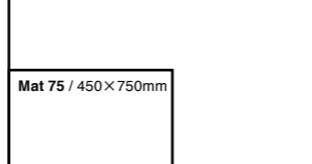

Mat 75 / 450×750mm



Model	Size	Price
Mat 75 T19-0082/75NT	450×750mm	¥3,800+税
Half rug 140 T19-0082/140N	900×1400mm	¥14,000+税

◎こちらのページに掲載されている製品は、ハンドメイドで生産されています。生産毎によりサイズや色の濃淡、材質の風合いに多少の個体差がございます。製品の特性としてご理解下さい。◎材質の性質上、設置面等に色移りする場合がございます。

## Denim floor rug S

材質：コットン100%

Model A659-602DBL

1000×1500mm

¥6,800+税



## Denim mat

材質：コットン100%

Model A659-601DBL

500×750mm

¥1,800+税



◎こちらの製品は、ハンドメイドで生産されています。生産毎により色の濃淡や、材質の風合いに多少の個体差がございます。製品の特性としてご理解下さい。  
◎材質の性質上、設置面等に色移りする場合がございます。



## PVC mat

材質：ポリ塩化ビニル



### Navy×Yellow

Model	Size	Price
S H19-0078S/NYL	H.10 400×600mm	¥1,500+税
M H19-0078M/NYL	H.10 500×700mm	¥2,200+税
L H19-0078L/NYL	H.10 600×900mm	¥3,200+税



### Gray×Red

Model	Size	Price
S H19-0079S/GRD	H.10 400×600mm	¥1,500+税
M H19-0079M/GRD	H.10 500×700mm	¥2,200+税
L H19-0079L/GRD	H.10 600×900mm	¥3,200+税

## PVC coil mat

材質：ポリ塩化ビニル



### Mustard

Model	Size	Price
S H19-0080S/MS	H.12 400×600mm	¥1,700+税
M H19-0080M/MS	H.12 500×700mm	¥2,500+税
L H19-0080L/MS	H.12 600×900mm	¥3,600+税

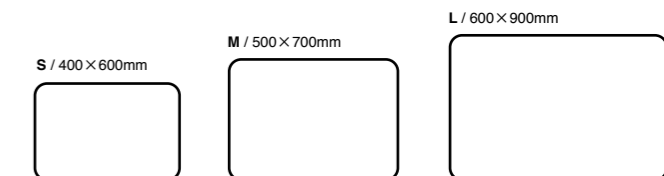

◎こちらの製品は、ハンドメイドで生産されています。生産毎によりサイズや色の濃淡、材質の風合いに多少の個体差がございます。製品の特性としてご理解下さい。  
◎材質の性質上、設置面等に色移りする場合がございます。



### Double gauze cotton throw / blanket

材質：コットン100%



Blue



Gray

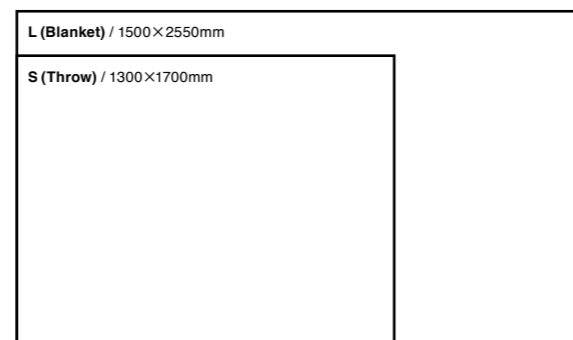

	Model	Size	Price	
S / Blue	T19-0088S/BL	1300×1700mm	¥4,900+税	4 997337 061773
S / Gray	T19-0088S/GY	1300×1700mm	¥4,900+税	4 997337 061766
L / Blue	T19-0088L/BL	1500×2550mm	¥7,400+税	4 997337 061797
L / Gray	T19-0088L/GY	1500×2550mm	¥7,400+税	4 997337 061780

◎こちらのページに掲載されている製品は、ハンドメイドで生産されており、生産毎によりサイズや色の濃淡、材質の風合いに多少の個体差がございます。製品の特性としてご理解下さい。  
◎材質の性質上、設置面等に色移りする場合がございます。

### Double gauze cotton cushion cover

材質：コットン100%

450×450mm

¥1,900+税

LOT 2pcs

Blue

Model T19-0089BL



4 997337 061810



Gray

Model T19-0089GY



4 997337 061803



### Double gauze linen cushion cover

材質：コットン77%、リネン23%

450×450mm

¥2,400+税

LOT 2pcs

Blue

Model T19-0090BL



4 997337 061834



Gray

Model T19-0090GY

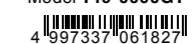

4 997337 061827



### Washed cotton square box cushion

材質：コットン100%

H.100 450×450mm

¥3,900+税

Green

Model T19-0086GN



4 997337 061704



Purple

Model T19-0086PL



4 997337 061711



Beige

Model T19-0086BE



4 997337 061728



◎こちらのページに掲載されている製品は、ハンドメイドで生産されており、生産毎によりサイズや色の濃淡、材質の風合いに多少の個体差がございます。製品の特性としてご理解下さい。  
◎材質の性質上、設置面等に色移りする場合がございます。





### Corduroy slippers EV

材質：ポリエステル、TPR樹脂

S) Women H.90 W.270 D.110mm ..... ¥1,200+税  
L) Men H.100 W.300 D.130mm ..... ¥1,300+税



バッグ付属



**Woman / Beige**

Model T20-0224S/BE

4 997337 069281



**Woman / Wine**

Model T20-0224S/WN

4 997337 069288



**Woman / Deep turquoise**

Model T20-0224S/TQ

4 997337 069311

**Men / Beige**

Model T20-0224L/BE

4 997337 069366

**Men / Wine**

Model T20-0224L/WN

4 997337 069373

**Men / Deep turquoise**

Model T20-0224L/TQ

4 997337 069380



**Woman / Green**

Model T20-0224S/GN

4 997337 069328



**Woman / Gray**

Model T20-0224S/GY

4 997337 069335



**Woman / Mustard yellow**

Model T20-0224S/YL

4 997337 069342

**Men / Green**

Model T20-0224L/GN

4 997337 069397

**Men / Gray**

Model T20-0224L/GY

4 997337 069403

**Men / Mustard yellow**

Model T20-0224L/YL

4 997337 069410

### PU slippers EV

材質：ポリウレタン、TPR樹脂

S) Women H.90 W.270 D.110mm ..... ¥1,200+税  
L) Men H.100 W.300 D.130mm ..... ¥1,300+税



バッグ付属



**Woman / Navy**

Model T20-0226S/NB

4 997337 069588



**Woman / Black**

Model T20-0226S/BK

4 997337 070539



**Woman / Brown**

Model T20-0226S/BR

4 997337 070515

**Men / Navy**

Model T20-0226L/NB

4 997337 069595

**Men / Black**

Model T20-0226L/BK

4 997337 070546

**Men / Brown**

Model T20-0226L/BR

4 997337 070522



TABLE CLOTH  
PICNIC RUG  
BED COVER  
TAPESTRY  
AND MORE..

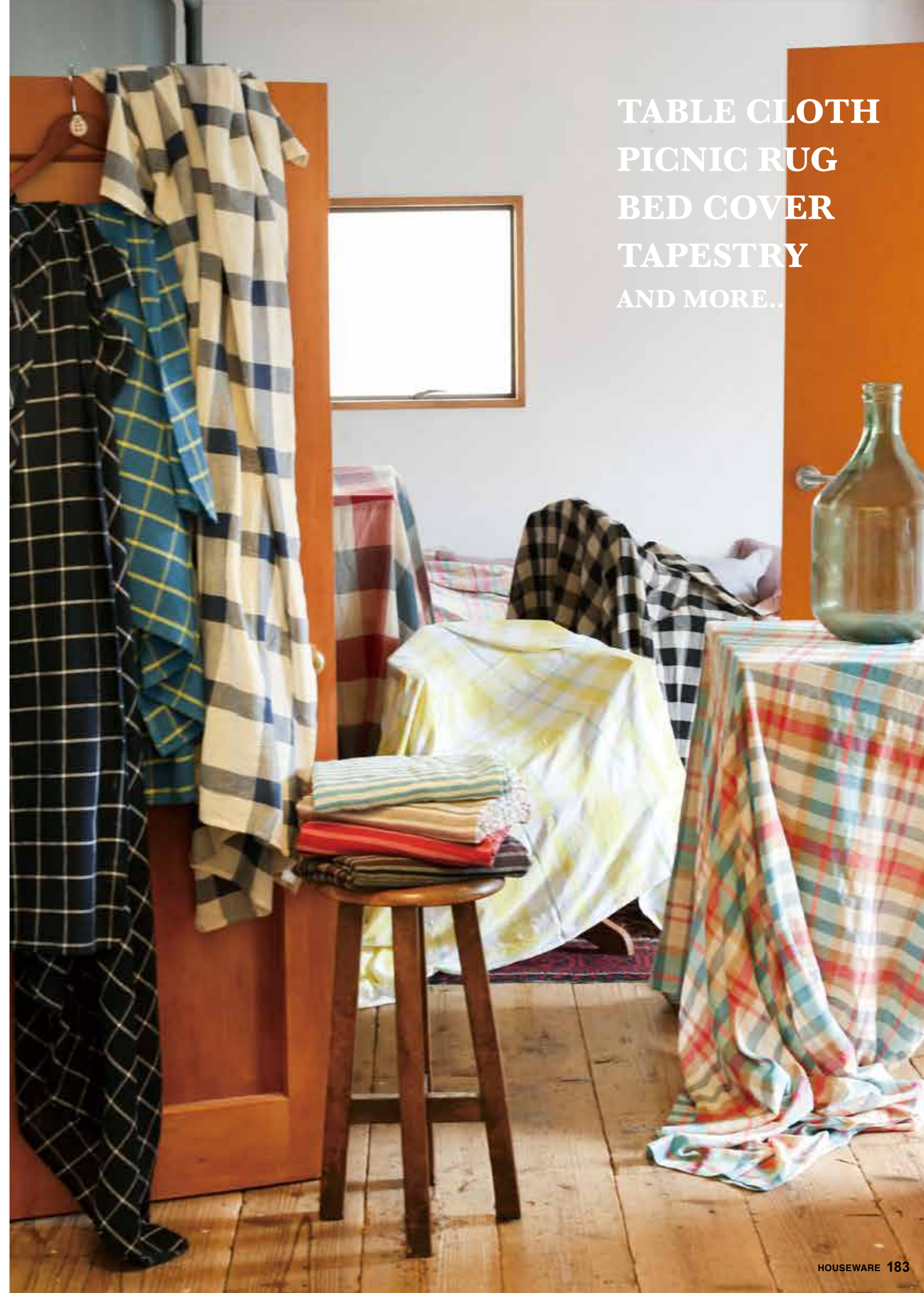

# MULTI CLOTHES



**Multi cloth**  
Model S159-54  
1500×2250mm  
¥1,400+税  
材質: コットン



◎こちらの製品はハンドメイドです。染色の際に生地が縮み、多少サイズに個体差がございます。また、多少のムラ・糸のほつれ・糸飛び等がございます。商品の特性としてご理解ください。  
◎インド綿特有のニオイが気になる場合は、風通しの良い場所で陰干しすることにより解消されます。洗濯の際は、他の物と分けて洗ってください。

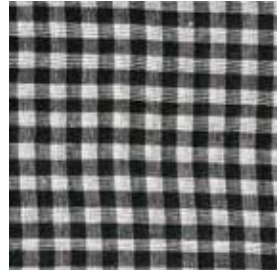

**H**  
4 997337 954082



**P**  
4 997337 954174



**U**  
4 997337 954228



**AA**  
4 997337 954297



**AB**  
4 997337 309547



**AG**  
4 997337 954358



**AJ**  
4 997337 954389



**AX**  
4 997337 954525



**BA**  
4 997337 954556



**BD**  
4 997337 954587



**BG**  
4 997337 954617



**BH**  
4 997337 954624



**CHYE**  
4 997337 076531



**CHBW**  
4 997337 076548



**CHPK**  
4 997337 076555



**STBK**  
4 997337 076562



**STWT**  
4 997337 076579

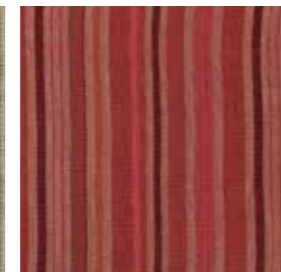

**STRD**  
4 997337 076586

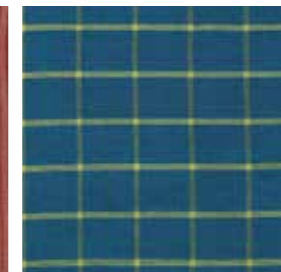

**CHBL**  
4 997337 076593



**CHNW**  
4 997337 076609



**CHLB**  
4 997337 076616

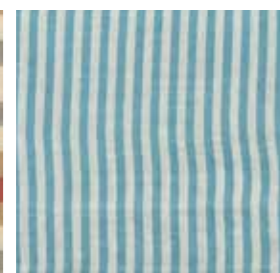

**STBL**  
4 997337 076623



**CHNB**  
4 997337 076630



**CHNR**  
4 997337 076647



## Multi cloth "Solid color"

Model S359-36  
1500×2250mm  
¥1,200+税  
材質: コットン

◎こちらの製品はハンドメイドです。染色の際に生地が縮み、多少サイズに個体差がございます。◎多少のムラ・糸のほつれ・糸飛び等がございます。◎生産毎に色の濃淡や、材質の風合いに多少の個体差がございます。商品の特性としてご理解ください。◎インド綿特有のニオイが気になる場合は、風通しの良い場所で陰干しすることにより解消されます。◎洗濯の際は、他の物と分けて洗ってください。



**G) Tan**  
4 997337 593670



**H) Sand**  
4 997337 593687

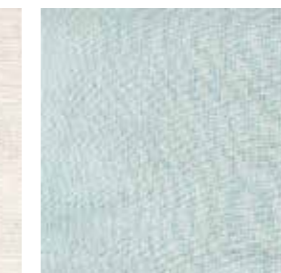

**L) Marine blue**  
4 997337 936118



**N) Bamboo**  
4 997337 936132

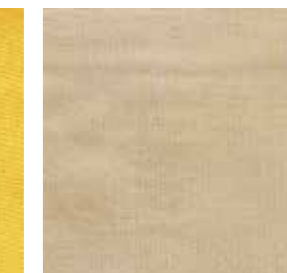

**P) Biscotti**  
4 997337 936149



**Q) Steel gray**  
4 997337 936156



**R) Seaport**  
4 997337 936163

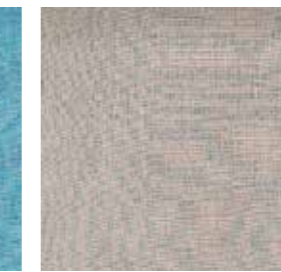

**T) Rock ridge**  
4 997337 936187

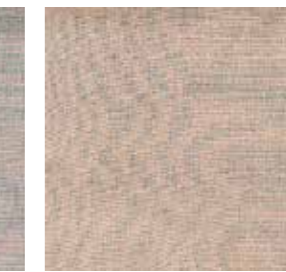

**W) Atmosphere**  
4 997337 936217



**A) Prairie**  
4 997337 593618

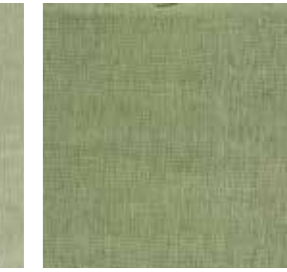

**B) Green tea**  
4 997337 593625



**C) Lavender**  
4 997337 593632



**D) Midnight**  
4 997337 593649



**E) Jelly**  
4 997337 593656



**F) Sunbeam**  
4 997337 593663

**Printed multi cloth**

Model S459-234  
1500×2250mm  
¥2,300+税  
材質：コットン



**P03**  
4 997337 923439



**P08**  
4 997337 923484



**P09**  
4 997337 923491



**P11**  
4 997337 112345



**P13**  
4 997337 132343



**P17**  
4 997337 172349



**P18**  
4 997337 182348

◎こちらの製品はハンドメイドです。  
染色の際に生地が縮み、多少サイズに個体差がございます。  
◎多少のムラ・糸のほつれ・糸飛び等がございます。  
◎生産毎に色の濃淡や、材質の風合いに多少の個体差がございます。商品の特性としてご理解下さい。  
◎インド綿特有のニオイが気になる場合は、風通しの良い場所で陰干しすることにより解消されます。  
◎洗濯の際は、他の物と分けて洗ってください。

**Mexican throw**

1750×1250mm  
¥3,200+税  
材質：コットン60%、ポリエステル40%



**Blue**  
Model G21-0318BL  
4 997337 075930

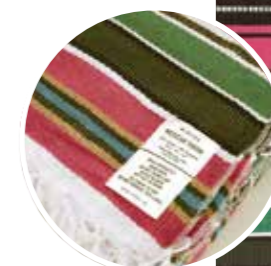

**Pink**  
Model G21-0318PK  
4 997337 075923



**Orange**  
Model G21-0318OR  
4 997337 075916

◎こちらのページに掲載されている製品は、ハンドメイドです。  
生産毎にサイズの個体差がございます。  
また、多少のムラ・糸ほつれ・糸飛び等がございます。  
製品の特性としてご理解ください。

**Acrylic blanket**

Model K659-661  
1300×2250mm  
¥2,900+税  
材質：アクリル 80%  
ポリエステル 20%



**A**  
4 997337 166195



**B**  
4 997337 266192



**C**  
4 997337 366199



**D**  
4 997337 466196



**E**  
4 997337 566193

◎こちらの製品は、ハンドメイドで生産されております。生産毎により色の濃淡や、材質の風合いに多少の個体差がございます。製品の特性としてご理解ください。◎材質の性質上、設置面等に色移りする場合がございます。

